



Dry Cleaning Presses Scissor "S" Series

Models 471/481/491 Leggers

Models 421/461/47U/191 Utilities



Model 421SR Utility
* Shown with optional Integrated Vacuum



Model 491SA Legger

- Presses available as Hot Heads
 - Multiple buck sizes and configurations to choose from
 - Patented controls allow head closing with either hand
 - Electrical power cord provided for simplified installation
 - Optional Integrated Vacuum - 120 or 230 volt single phase
 - Fast head closing and opening for maximum operator efficiency
 - Model 191SR Mushroom serves as Pant Topper and Small Utility
- Easily accessible pressure selector switch allows a firm or soft press
 - Options include Iron Tray, Sleeve Board, Water Spray, Hanger Rack, Timer, Sandwich Leaf, and Offset Conversion Kit

This latest generation of Forenta Scissor Presses sport many improvements which add to its reputation as a simple, yet versatile press. With multiple buck shapes and options to choose from, this press will quickly become the workhorse in your pressing bay.

www.forentausa.com

Tel: 423-586-5370 • Email: info@forentausa.com

Made in USA

"S" SERIES SPECIFICATIONS

Electrical connection without optional built-in vacuum:

- 100-240 VAC single-phase, 50/60 Hz, 0.5 amp
- IEC 60320 C13 socket for press controls

Steam connections:

- 1/2 NPT for supply and condensate
- 75-85 psi (0.52-0.59 MPa)
- Steam consumption at 80 psi(0.55 MPa):
- 1 BHP (34.5 lb/hr)(15.6 kg/hr)

Compressed air connection:

- 3/8 NPT
- Recommended Air Pressure: 80 psi (0.55 MPa)
- Free air/cycle at 80 psi (0.55 MPa): 0.5 cubic feet (13.5 liters)

Vacuum connection (Central):

- 1-1/4 NPT
- 20-30 inches of water (50-75 millibar)
- 75 cubic feet/minute (127 cubic meters/hour)

Press electrical connection with optional 120 volt vacuum:

- 110-120 VAC single-phase, 60 Hz, 8.4 amps, (UL motor)
- IEC 60320 C13 socket for press controls and blower

Press electrical connection with optional 220 volt vacuum:

- 220 VAC single-phase, 60 Hz, 4.3 amps, (UL motor)
- IEC 60320 C13 socket for press controls and blower

Optional hand iron electrical connection (external wiring, not part of press internal wiring):

- 115 VAC or 230 VAC single-phase, 50/60 Hz
- Conduit connection
- 800 watts
- Approximate hourly consumption: 0.5 KWH

Optional water spray cold water connection:

- 1/4 NPT
- 40-80 psi (0.3-0.55 MPa)
- 1 gallon/minute (3.8 liter/minute)

BUCK DIMENSIONS (unpadded)

191

Mushroom
Utility

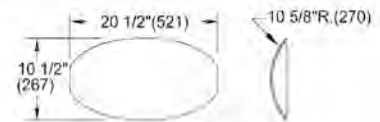

421

Utility

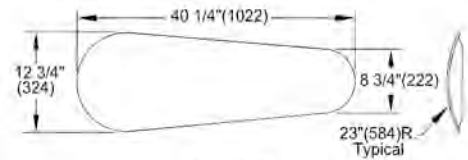

461

Utility

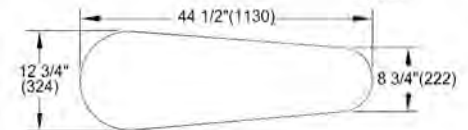

47U

Utility

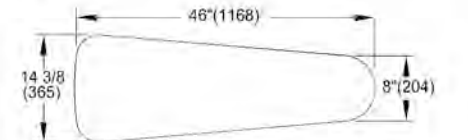

471

Legger

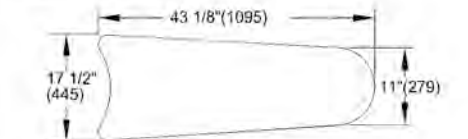

481

Legger-
Utility

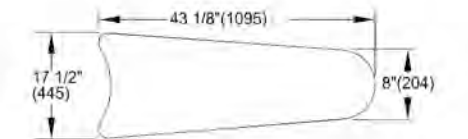

491

Oversized
Legger

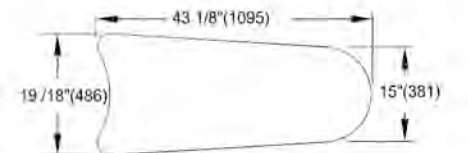

Optional Attachment Kits

	421SR / 461SR / 47USR (Small end right)	421SL / 461SL (Small end left)	471SN / 481SN 471SA / 481SA	491SA	191SR
K-695-1 Steam/Electric Iron Attachment, 115 Volt	•		•	•	
K-695-2 Steam/Electric Iron Attachment, 230 Volt	•		•	•	
K-696-1 Steam/Electric Iron Attachment, 115 Volt		•			•
K-696-2 Steam/Electric Iron Attachment, 230 Volt		•			•
K-697 All-Steam Iron Attachment	•		•	•	
K-698 All-Steam Iron Attachment		•			•
K-198 Sleeve Board	•	•	•	•	•
K-699 Water Spray	•	•	•	•	•
K-690 Timer Kit	•	•	•	•	•
K-704 Hanger Rack	•	•	•	•	•
K-693 Sandwich Leaf			•		
K-694 Sandwich Leaf				•	
K-691-1 Integrated Vacuum, 120 Volt, 1 Ph.	•		•	•	•
K-691-2 Integrated Vacuum, 220 Volt, 1 Ph.	•		•	•	•
K-692-1 Integrated Vacuum, 120 Volt, 1 Ph.		•			
K-692-2 Integrated Vacuum, 220 Volt, 1 Ph.		•			
K-705 Offset Conversion Kit		•			

Models: 421SR, 461SR & 47USR

Electrical Requirements

Voltage: 100-240VAC, 1PH, 50/60Hz, 0.35-0.19 Amps

Electrical Requirements with optional Built-in Vacuum

Voltage: 110-120VAC, 1PH, 60Hz, 8.4 Amps

Voltage: 220VAC, 1PH, 60Hz, 4.3 Amps

Steam, Air, Vacuum & Water Requirements

Steam Inlet

Steam Outlet

Rec. steam pressure

Steam consumption @ 80psig(552 kPa)

Compressed air

Air consumption

Rec. air pressure

Vacuum Connection

Water Inlet (for optional water spray)

Weight (crated)

Shipping

lbs 700
kg 317

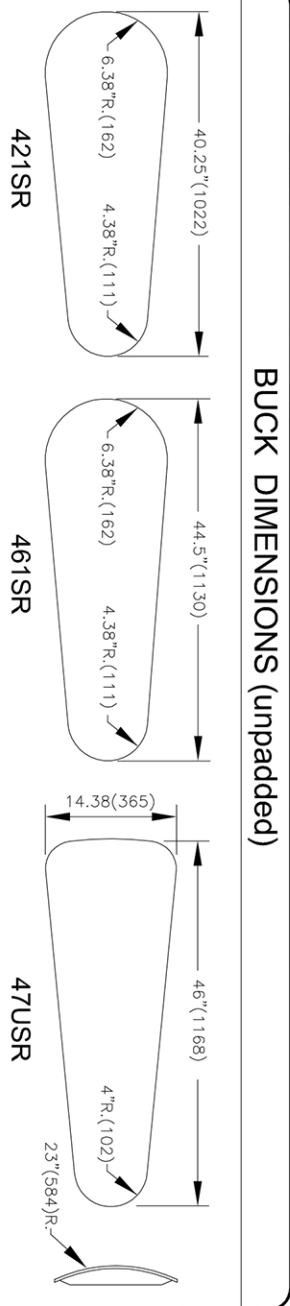

Detail Line Drawing (millimeters shown in parentheses)

- 1 - Control Push Buttons
- 2 - Steam Inlet connection
- 3 - Air connection
- 4 - Steam Outlet connection
- 5 - Vacuum Connection
- 6 - Electrical Connection (7'6" ~ 3 Prong Electrical Cord)
- 7 - Water Connection (For optional water spray)
- 8 - Optional Built-in Vacuum

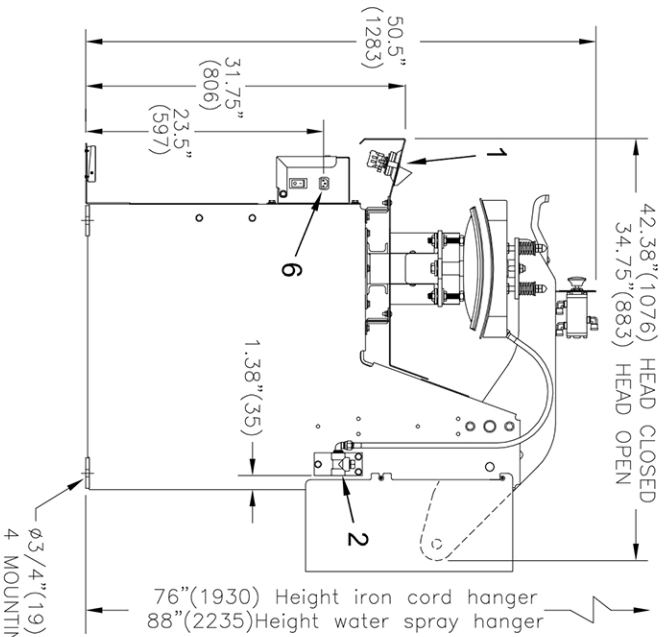

RIGHT SIDE VIEW

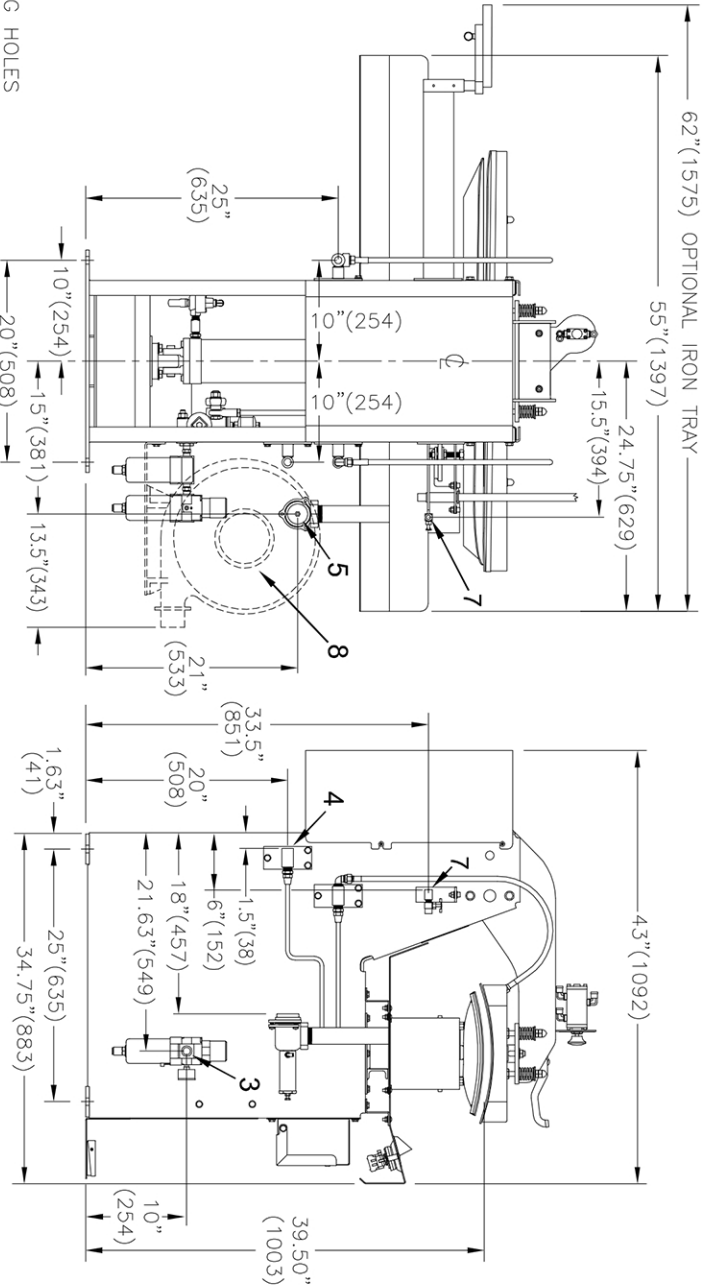

REAR VIEW

LEFT SIDE VIEW

Models: 421SL & 461SL

Electrical Requirements

Voltage: 100-240VAC, 1PH, 50/60Hz, 0.35-0.19 Amps
 Electrical Requirements with optional Built-in Vacuum
 Voltage: 110-120VAC, 1PH, 60Hz, 8.4 Amps
 Voltage: 220VAC, 1PH, 60Hz, 4.3 Amps

Steam, Air, Vacuum & Water Requirements

Steam Inlet NPT 1/2"
 Steam Outlet NPT 1/2"
 Rec. steam pressure PSIG 75-85
 MPa 0.52-0.59

Steam consumption @ 80psig(552 kPa)

BHP 1
 kg/hr 15.6
 lb/hr 34.5
 NPT 3/8"

Compressed air

free air/cycle at 80psig 0.48 FT³
 free air/cycle at 0.55MPa 13.5 liters

Rec. air pressure

PSIG 80
 MPa 0.55
 NPT 1 1/4"
 NPT 1/4"

Vacuum Connection

Water Inlet (for optional water spray)

Weight (crated) lbs 700
 kg 317

BUCK DIMENSIONS (unpadded)

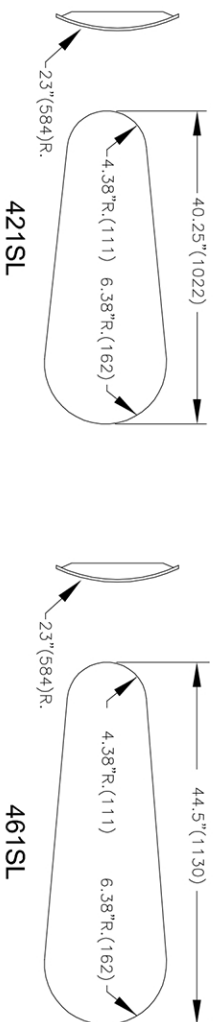

Detail Line Drawing (millimeters shown in parentheses)

- 1 - Control Push Buttons
- 2 - Steam Inlet connection
- 3 - Air connection
- 4 - Steam Outlet connection
- 5 - Vacuum Connection
- 6 - Electrical Connection (7/6" ~ 3 Prong Electrical Cord)
- 7 - Water Connection (For optional water spray)
- 8 - Optional Built-in Vacuum

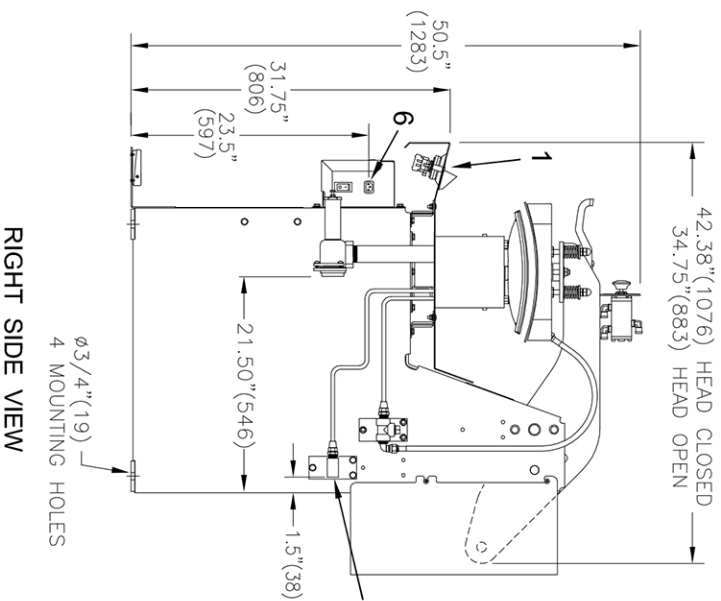

RIGHT SIDE VIEW

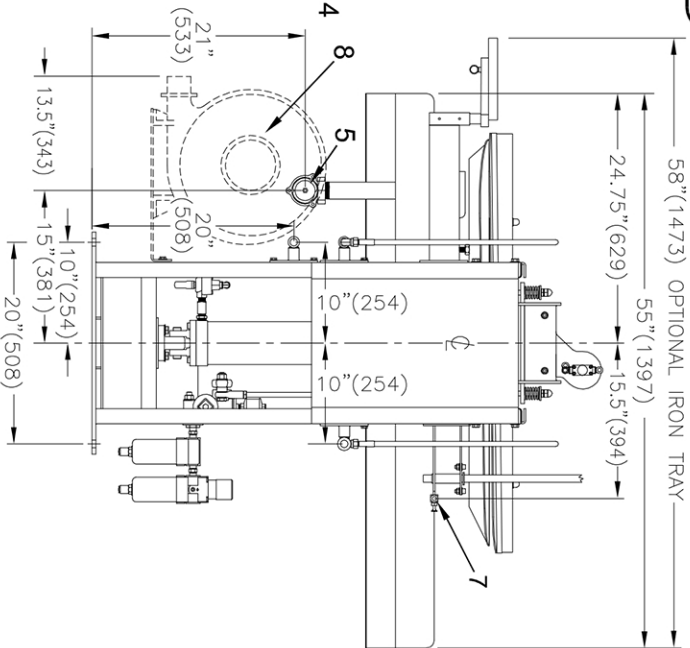

REAR VIEW

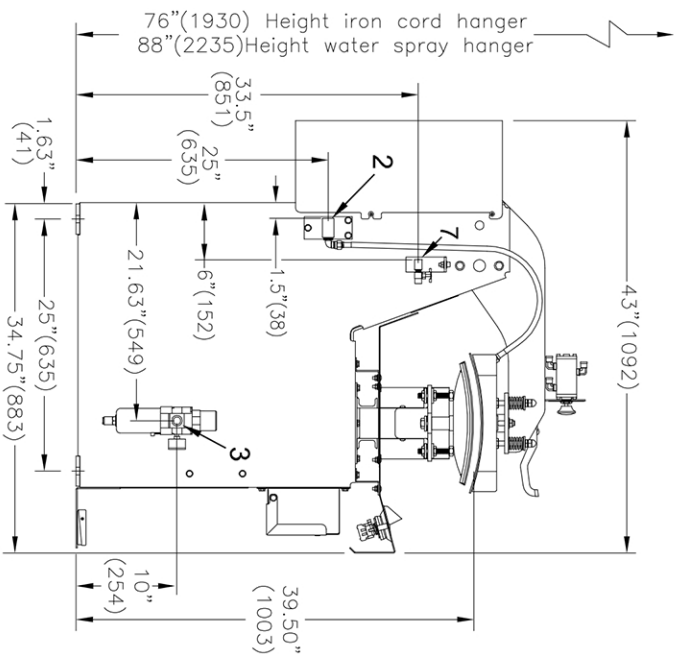

LEFT SIDE VIEW

Models: 471SA, 481SA & 491SA

Electrical Requirements

Voltage: 100-240VAC, 1PH, 50/60Hz, 0.35-0.19 Amps

Electrical Requirements with optional Built-in Vacuum

Voltage: 110-120VAC, 1PH, 60Hz, 8.4 Amps

Voltage: 220VAC, 1PH, 60Hz, 4.3 Amps

Steam, Air, Vacuum & Water Requirements

Steam Inlet

Steam Outlet

Rec. steam pressure

Steam consumption @ 80psig(552 kPa)

Compressed air

Air consumption

Rec. air pressure

Vacuum Connection

Water Inlet (for optional water spray)

Weight (grated)

Shipping

NPT 1/2"

NPT 1/2"

PSIG 75-85

MPa 0.52-0.59

BHP 1.5

kg/hr 23.5

lb/hr 51.8

NPT 3/8"

free air/cycle at 80psig 0.48 FT³

free air/cycle at 0.55MPa 13.5 liters

PSIG 80

MPa 0.55

NPT 1 1/4"

NPT 1/4"

lbs 740

kg 335

BUCK DIMENSIONS (unpadded)

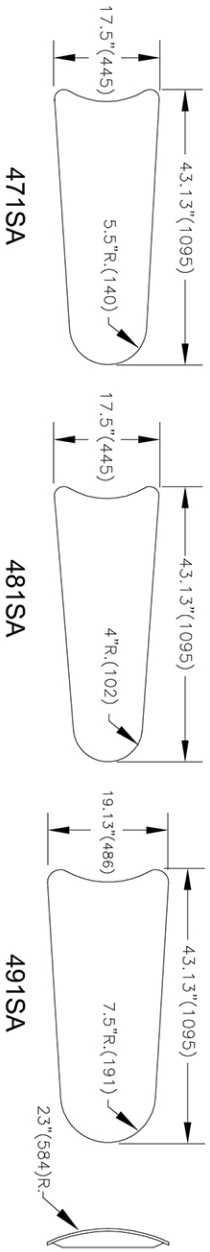

Detail Line Drawing (millimeters shown in parentheses)

- 1 - Control Push Buttons
- 2 - Steam Inlet connection
- 3 - Air connection
- 4 - Steam Outlet connection
- 5 - Vacuum Connection
- 6 - Electrical Connection (7'6" ~ 3 Prong Electrical Cord)
- 7 - Water Connection (For optional water spray)
- 8 - Optional Built-in Vacuum

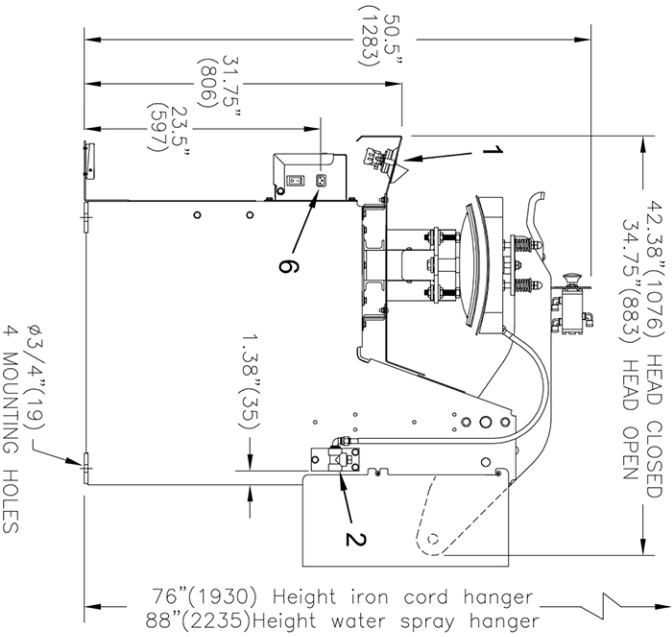

RIGHT SIDE VIEW

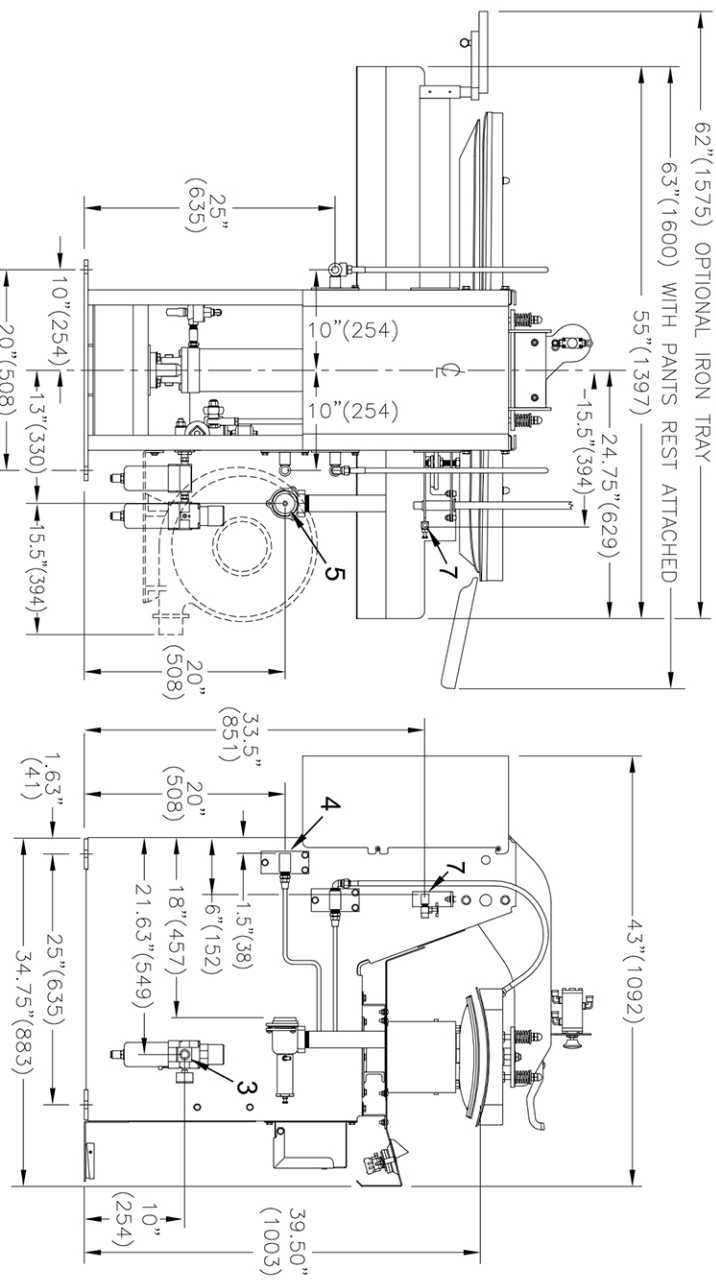

REAR VIEW

LEFT SIDE VIEW